



- UK** Decorative spotlights to create the atmosphere you desire.
- FR** Spots décoratifs pour créer vos ambiances.
- DE** Dekoratives Spotlight um Ihre gewünschte Atmosphäre zu kreieren.
- ES** Bombillas decorativas para crear la atmosfera que desee.
- NL** Decoratieve spots om de gewenste sfeer te creëren



X 24 inside  
LEDSTAR



### Overall Specification \*

Wattage/Puissance/Leistung/Wattage/Vatija	3.0 Watt
Experienced Wattage/Equivalent incandescent/Empfundene Wattleistung /Ervaren wattage/Vatija de experienced	20 Watts
Available fittings/Culots disponibles/Fassungen/Beschikbare fittings/disponibles	GU5.3, GU10
Beaming angle/Diffusion de la lumière/Streubreite des Lichts /Lichthoek /ángulo agudo	60°
Life time/Durée de vie/Lebensdauer/Levensduur/esperanza de vida	25000 hours



### Technical Data \*\*

Article Number	Volt	Fitting	CRI	CCT	Lumen	Candela	EAN Code
LED-S0301-LUS	12V	GU5.3	75	4500K	90	106	3700514700119
LED-S0302-LUS	12V	GU5.3	66	3000K	80	95	3700514700126
LED-S0303-LUS	220V	GU10	75	4500K	90	106	3700514700133
LED-S0304-LUS	220V	GU10	66	3000K	80	95	3700514700140

### Flux Diagram \*\*\*

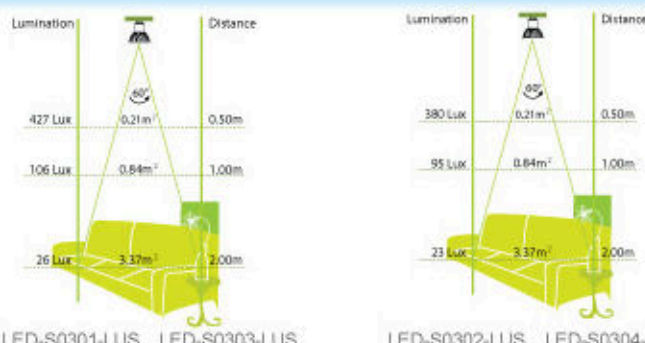

Lighting power (in Lux) needed for:



\* Overall Specification    Características comunes    Spezifikationen    Globale specificatie    Especificaciones generales    Specifiche Generali    Especificações gerais    Γενική Προδιαγραφή    Övergripande specifikation    Yleiset tiedot    Generelle spesifikasjoner    Samlede spesifikationer    Obecné údaje    Обща спецификация    Általános adatok    Charakterystyka ogólna    Sührinné parametre    Skupne specifikacije    Ukupni tehnički podaci    Specificații generale    Обща спецификация    Üldspetsifikatsioon    Bendrasis aprašas    Vispārējā specifikācija    Opšte specifikacije    \*\* Technical Data    Données techniques    Technische Besonderheiten    Technische gegevens    Datos técnicos or Ficha técnica    Dati Tecnici    Dados técnicos    Τεχνικά Στοιχεία    Tehnikski data    Tekniset tiedot    Tekniske data    Tekniske data    Technické údaje    Техніческі данні    Műszaki adatok    Dane techniczne    Technické údaje    Tehnički podatki    Tehnički podaci    Date tehnice    Техніческі данні    Tehnised andmed    Techniniai duomenys    Tehniške dati    Tehnički podaci    \*\*\* Flux diagram    Diagramme de flux    Flux-Diagramm    Flux-diagram    Diagrama de flux    Diagramma di flusso    Fluxo diagrama    Διαγράμμα ροής    Flux diagram    Flux kaavio    Flux diagram    Flux diagram    Flux diagram    Áram-diagramm    Áram-diagramm    Flux wykres    Flux diagram    Tokovni diagram    Diagrama toka    Diagrama de flux    Flux diagrama    Flux diagramm    Srauto schema    Flux diagramma    Diagram toka

## Color Temperature Chart \*

CCT: White(4500°K) / CRI: 75

CCT: Warm White(3000°K) / CRI: 66

CCT: White(4500°K) / CRI: 75

CCT: Warm White(3000°K) / CRI: 66

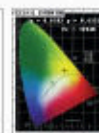
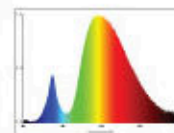
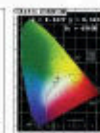
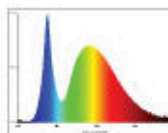
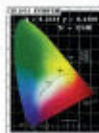
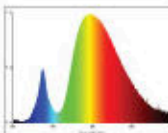
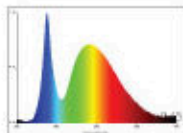

LED-S0301-LUS

LED-S0302-LUS

LED-S0303-LUS

LED-S0304-LUS

## Industrial Drawing \*\*

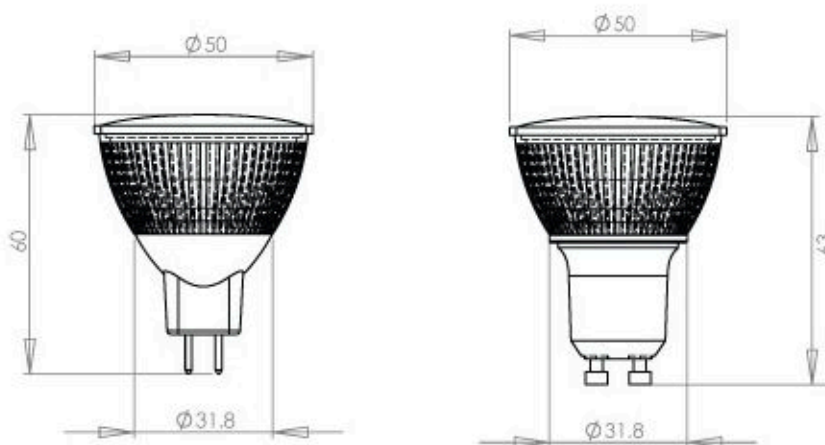

## Packaging Picture \*\*\*



\* Color Temperature Chart Diagramme de température de couleur Diagramm der Farbtemperatur Grafiek kleurtemperatuur Gráfico del color de temperatura Carta della Temperatura del Colore Tabela de temperatura das cores Εγγραφο χύδρονου θερμοκρασιών Färgtemperatur diagram Värnilämpölämpävaluko Fargetemperaturkart  
 \*\* Farvetemperatur-diagram Tablica teploty barev Таблица цветоых температур Színhőmérséklet-táblázat Wykres temperatury barwowej Graf teploty farieb Preglednica temperatur barv Tablica s temperaturama boje Tabelul temperaturii de culoare Czerwata na uzerobara teownepatupa Värivtemperatuuri kaart Spalvos temperatūros schema Krišiu temperatūras diagramma Dijagram temperatura boje Industrial Drawing Dessin industriel Skizze Industrielle tekening Plano técnico Disegno Industriale Desenho industrial Βιογραφικό Σχέδιο Industrinrning Valmistuskaavio Industriell tegning Teknisk tegning Technický náčres Чепрек Іпарі рај Schemat techniczny Премисловé креслене Индустрјска скица Индустрјски нацрт Сchemá Industrialá Индустрјпанен чепрек Тööjoonis Прамониніс брѣһныс Tehniskais rasējums Индустрјскі чертеж \*\*\* Packaging Picture Photo du packaging Verpackungsbild Verpakingsafbeelding Dibujo del embalaje Imagine della Confezione Imagem da embalagem Εικόνα Συσκευασίας Förpackningsbild Kuva pakkauksesta Pakningsbilde Emballagebilde Obrázek obalového materiálu Ypakoska Kép a csomagoláson Zdjecje opakowania Obrázok balenia Slika embalaže Slika na ambalaži Imagine ambalaj Czewa za opakowabe Pakendi pilt Pakuotės paveikslėlis Montāžas ilustrācija Silka pakovanja